



WORKSWELL SAFETIS EX-PROOF EARLY FIRE DETECTION THERMAL CAMERA

Release date: 13th of April 2021

Revision Number: 210413

Workswell s.r.o. introduces the new Thermal Imaging System designed for early fire detection and protection **Workswell SAFETIS EX-proof**. The wide usage of the product can be applied in many Fire-Safety fields requiring 24/7 protection such as waste bunkers, many types of warehouses, electrical substations, landfills, photovoltaic plants etc. Workswell pushed the limits forward and developed unique all-in-one system with built-in analysis, continuous measurement, visualization, control functions and alarming. **SAFETIS EX-Proof** camera can be used and controlled via integrated Web-server or via **SAFETIS Control Unit** with advanced features.

Workswell SAFETIS EX-proof camera offers great resolution of 640 x 512 px, sensitivity of 50 mK (0.05 °C) and fast response within milliseconds. The powerful communication interface allows connecting SAFETIS camera directly to any computer via Web-server or directly to **SAFETIS Control Unit** via Ethernet RJ45. The SAFETIS camera has integrated 7 digital outputs in the camera and 7 digital outputs in **SAFETIS Control Unit** that can be triggered at the same time if needed.



KEY FEATURES IN SAFETIS OUTDOOR

- Built-in **web-server** for control and stream
- **SAFETIS Control unit** for advanced visualization
- **High-protection heated outdoor housing IP67**
- Fully calibrated up to 550 °C (optional +1 500 °C)
- Resolution 336 px or 640 px detector up to 30 Hz
- Ethernet TCP/IP Process communication
- **Up to 7 digital alarm outputs in the camera**
- Infinity focus or optional focusing on target
- Advanced analytics, recording and alarming



SAFETIS Outdoor specification table			
Resolution	336 x 256 pixels		640 x 512 pixels
Image frequency	9 Hz or 30 Hz		9 Hz
Temperature ranges	-25 °C to +150 °C (-13 °F to 302 °F) -40 °C °C to +550 °C (-40 °F to 1 022 °F) optional temperature range +50 – 1 000 °C (122 °F to 1 832 °F) optional temperature range +400 – 1 500 °C (752 °F to 2 732 °F)		
Temperature sensitivity	0.05 °C (50 mK)		
Spectral range	7.5 – 13.5 μm		
Detector type	Uncooled VOx microbolometer		
Focus	Continuous manual (fixed focusable, min focus distance depends on lens)		
Calibration	Yes, including calibration certificate		
Web server	Yes, integrated with additional early fire detection functions		
FOV/Focal length 640 x 512	iFOV	Accuracy	Pixel size
FOV 45° x 37° / 13 mm	1.308 mrad	±2 % or ±2 °C	1.3 mm from 1 meter
FOV 32° x 26° / 19 mm	0.895 mrad	±2 % or ±2 °C	0.9 mm from 1 meter
FOV/Focal length 336 x 256	iFOV	Accuracy	Pixel size
FOV 45° x 35° / 6.8 mm	2.267 mrad	±2 % or ±2 °C	2.3 mm from 1 meter
FOV 35° x 27° / 9 mm	1.889 mrad	±2 % or ±2 °C	1.9 mm from 1 meter
FOV 25° x 19° / 13mm	1.308 mrad	±2 % or ±2 °C	1.3 mm from 1 meter
FOV 17° x 13° / 19mm	0.895 mrad	±2 % or ±2 °C	0.9 mm from 1 meter
SAFETIS EX-proof built-in functions (integrated web-server)			
Camera configuration	Built-in web-server for easy and fast sensor configuration, Google Chrome, Safari, Explorer or Firefox browser compatible, no external software required		
Monitoring and alarming	Extreme detection, MAX/MIN evaluation, Dynamic/Static measurement User Control Table (Logical rules and PLC connection), Selectable digital output for specific ROI result (OR/AND operators)		
Visualization	Real-time video streaming, Pallet settings, Overlay elements, Digital zooming, Numeric and statistical indicators, Input and Output overview panel		
Image correction	Non-Uniformity Correction asynchronous/synchronous/triggerable		
ROI	User definable measurement area (Point, Line, Polyline, Rect., Polygon, Circle) Multiple product selection for ROI presets (Manual or via Ethernet)		
Others	Real-time Clock, Emissivity correction, Multiple languages		



SAFETIS Outdoor Functions connected to SAFETIS CONTROL UNIT via SDK

Camera configuration	Camera is completely configured via SAFETIS SDK or web-server
Number of cameras	Up to 16 cameras connected to single SAFETIS Control unit
Monitoring and alarming	Advanced analytics functions, Extreme detection, MAX/MIN evaluation, Dynamic/Static measurements, User Control Table (Logical rules for PLC connection), Selectable digital outputs for specific ROI measurement analysis
Advanced analytics functions	Yes, eliminating of non-alarm triggers, eliminating of moving objects etc.
Graphical alarm visualization	Yes
Recording	Pre-alarm recording function allows to start recording before the alarms appear
Image recording	Yes
Fully radiometric recording	Yes
Logging	Yes
Visualization	Real-time video streaming from up to 16 cameras, Pallet settings, Overlay elements, Digital zooming, Numeric and statistical indicators
Visualization on desktop	Visualization can be reorganized according to customer wish
Graphs visualization from ROI	Yes
ROI	User definable measurement area (Point, Line, Polyline, Rect., Polygon, Circle)
Digital outputs	Up to 14 digital outputs (7 on the camera, 7 on the SAFETIS Control Unit)
Network and I/O connectivity	
Network	Ethernet for streaming and control (IEEE 802.3)
Network connectivity	Ethernet 100Mb/sec, RJ-45, Metal cable gland protection
Digital outputs on the camera	7 x Isolated open collector output (max 40 VDC), M12 circular thread
Environmental data, dimensions and power supply	
IP protection (Encapsulation)	IP67 with cable glands
Operating temperature	-25°C to +50°C (-13 °F to 122 °F)
Automatic heaters	Yes, including clearing the window from ice
Storage temperature	-40°C to +70°C (-40 °F to 158 °F)
Humidity	5% to 95% non-condensing
Dimensions and weight	483 x 172 x 167, 17.4 kg, stainless steel
Supply input, consumption	230 VAC/110 VAC, < 20 W
Mounting and certifications	More information in the housing datasheet



SAFETIS BUILT-IN WEB-SERVER

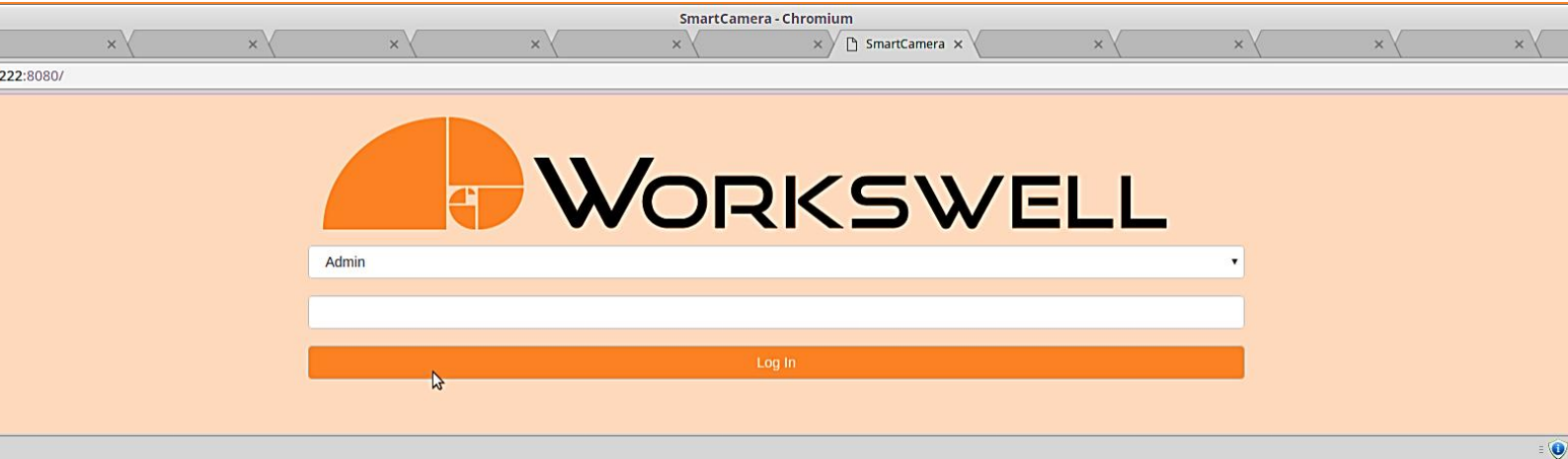

Web-server Key Points

- No external software needed and Windows, Linux or Mac OS fully compatible
- Full camera control and image streaming via standard web browser
- User-friendly configuration wizard with multiple user access mode
- Integrated operator visualization with indicator panel
- Available via Ethernet cable or wireless connectivity
- Camera updates
- Multilanguage

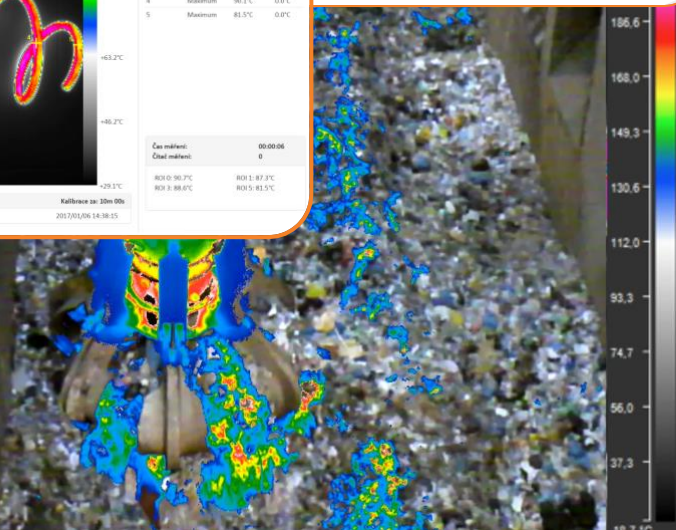
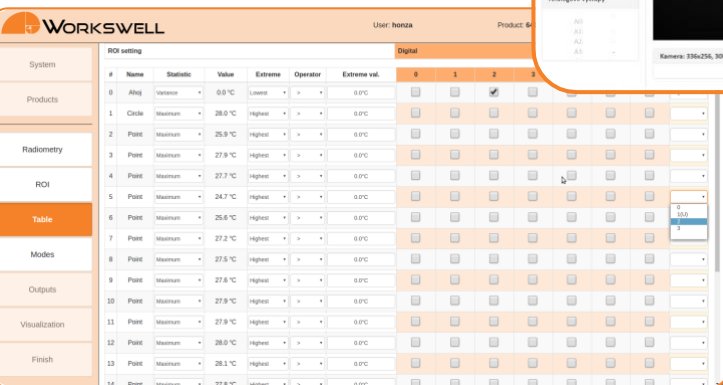
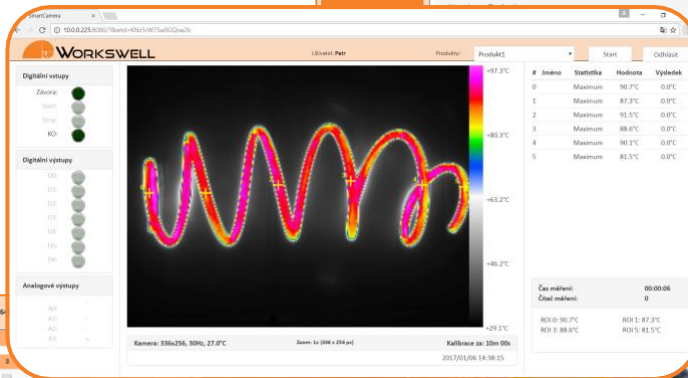
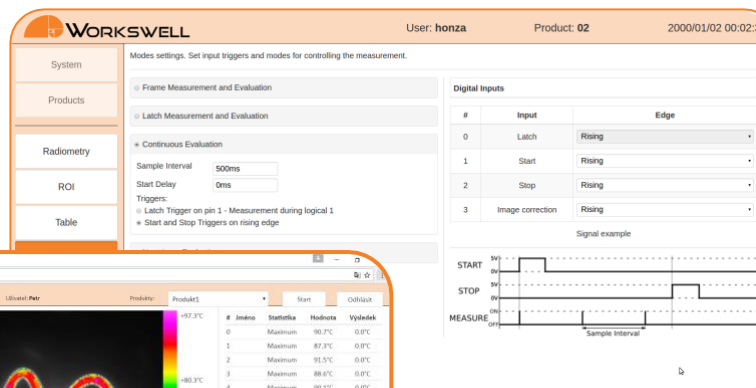

SAFETIS Control Unit – advanced 24/7 monitoring

- Up to 16 SAFETIS cameras at the same time
- Real-time streaming of each connected SAFETIS
- Advanced visualization and recording functions
- Start recording of radiometric video up to 30 s before alarm (pre-trigger), during alarm and 30 s after alarm
- Periodical recording of radiometric images
- Live graphs based on temperature values
- Position control of any connected SAFETIS PT
- Settings of all parameters of any connected SAFETIS
- 7 digital outputs

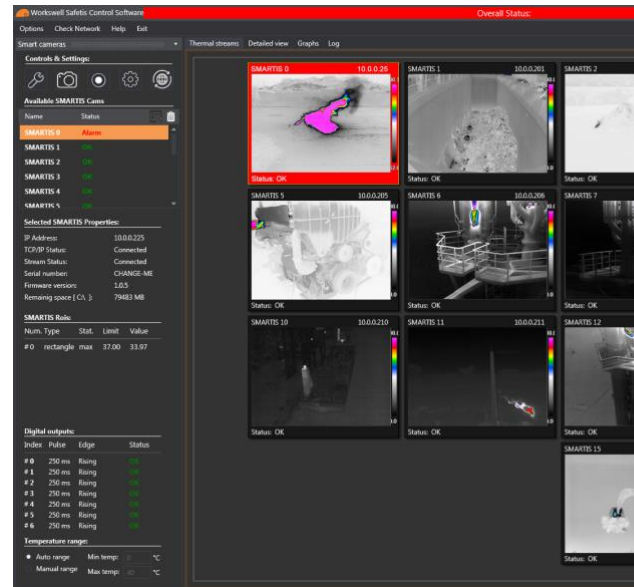

SAFETIS Control Unit has been developed for complex early fire detection and protection requiring 24/7 monitoring. This allows you to prevent critical situations and fire hazards that can damage huge values of company properties. Thanks to advanced SAFETIS Control Unit features, **all alarms are activated even before any fire related event starts**. The SAFETIS Control Unit is a special industrial controller with SDK software and sample Labview application for parameterization and visualization. The SAFETIS Control Unit is available in two versions for 8 or 16 SAFETIS cameras.

SAFETIS Control Unit allows to combine any kind of SAFETIS cameras, no matter if it is Outdoor, Indoor, EX-proof, Outdoor PT, Stainless Steel, low / high resolution or frame rate.

4 Disk Drive, max **8TB**
RAID 0, 1, 5, 10

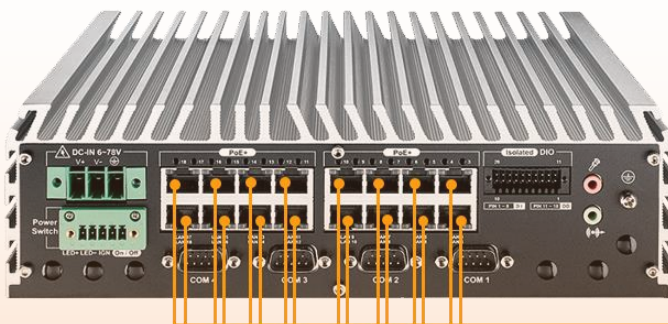

up to 16 cameras
at the same time



SAFETIS EX-proof dimensions (in millimeters)

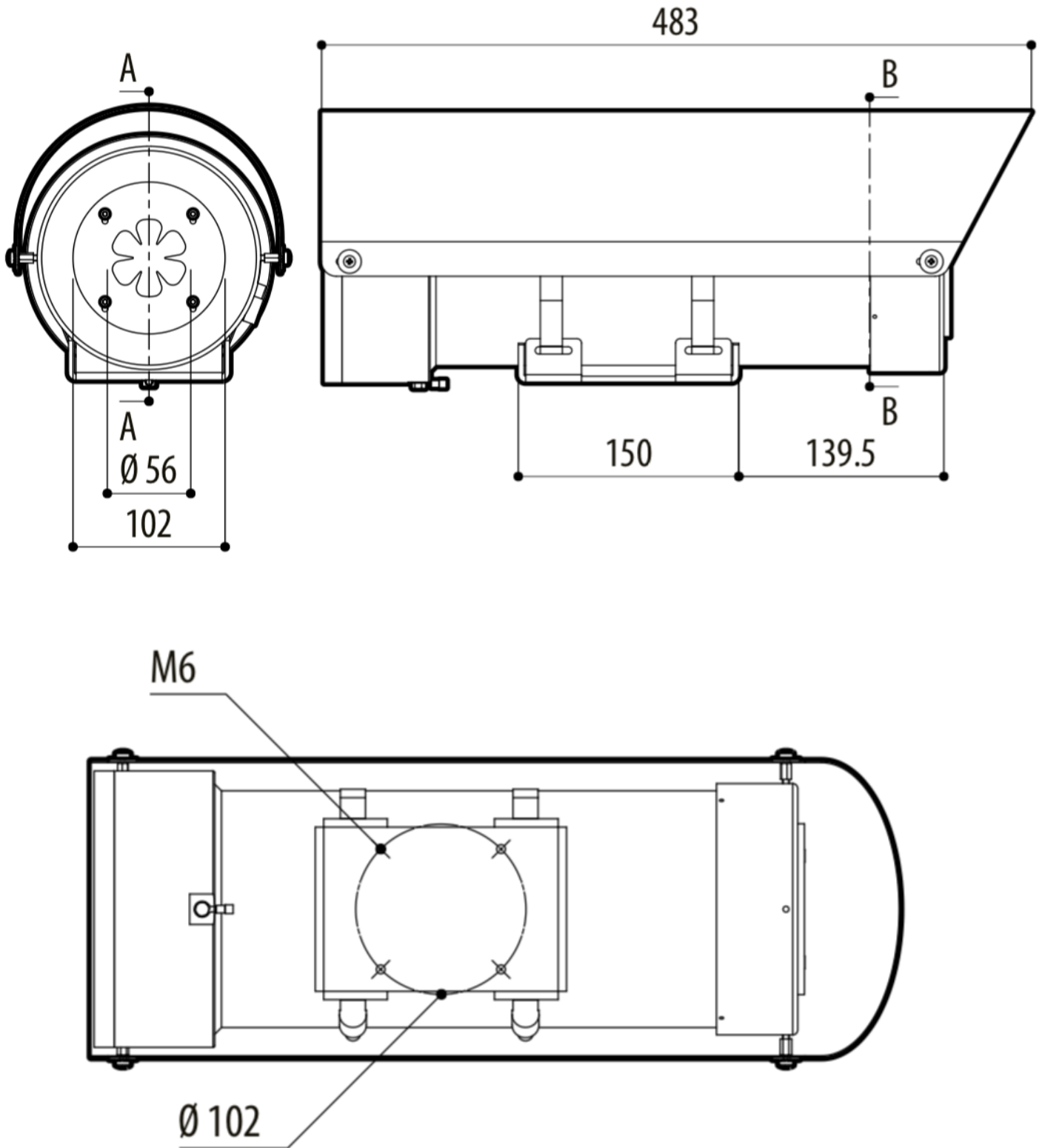

Contact information

WORKSWELL IN THE WORLD



Find our partners worldwide

www.workswell.eu/where-to-buy

SALES DEPARTMENT

Website: www.workswell.eu

E-mail: sales@workswell.eu

Mobile: +420 737 547 622

COMPANY CONTACT

Website: www.workswell.eu

E-mail: info@workswell.eu

Mobile: +420 725 877 063

OFFICE LOCATIONS

Europe - Prague

United States of America

Global partner network

www.workswell.eu

